

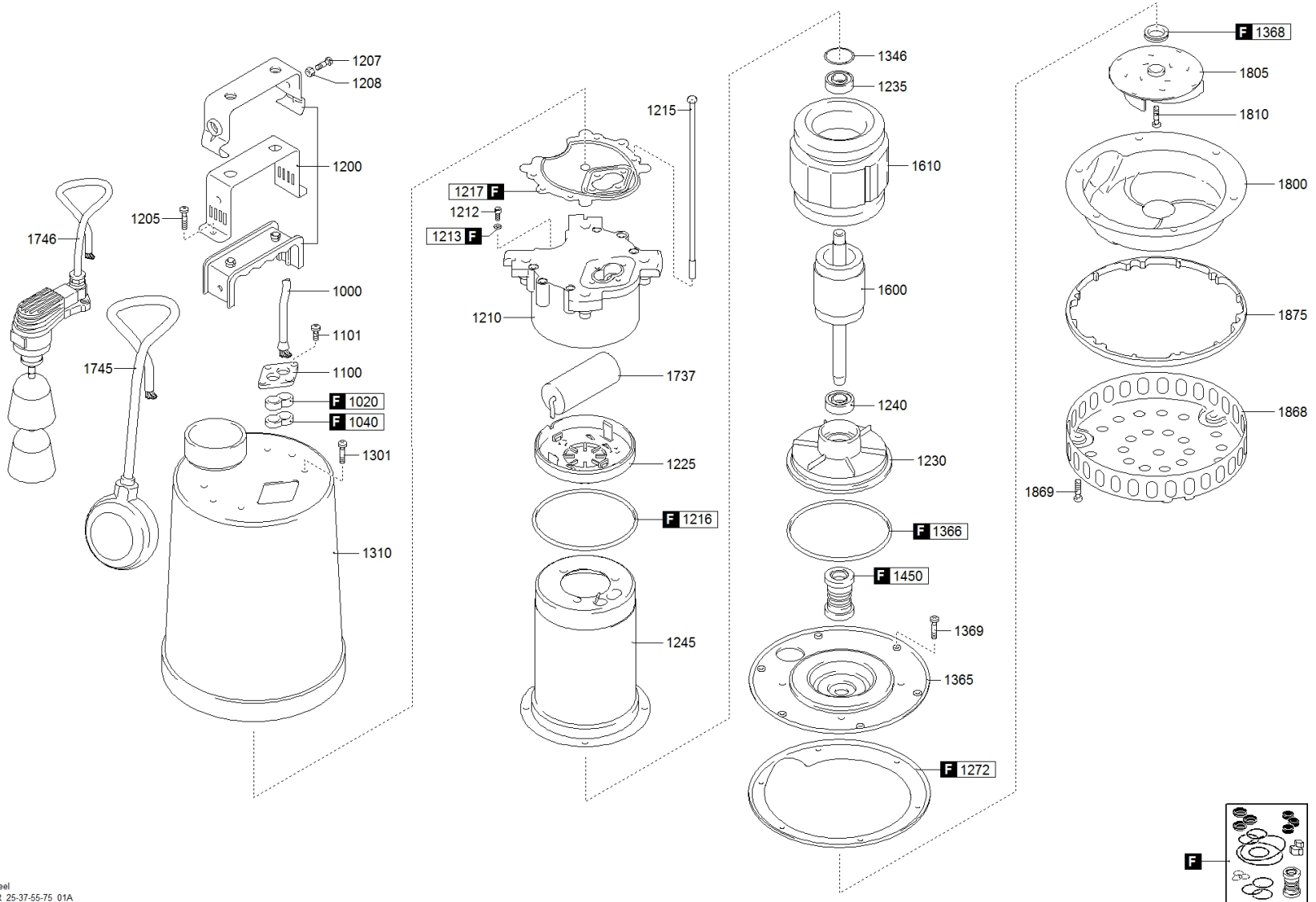

water solutions

5003.006 - DR-STEEL 55 M5 0 TG1U2300NN





water solutions



5003.006 - DR-STEEL 55 M5 0 TG1U2300NN

		Code	Description	Q.ty	Price (€)
F		608009002	MAINTENANCE KIT	1	
1000		250102304010100000	POWER CABLE	1	
1000		250102304010700000	POWER CABLE	1	
1020		235467024241	CABLE GLAND [POWER CABLE]	1	805884
1040		235678024236	RUBBER GASKET [POWER CABLE]	1	711017
1100		235439070012	CABLE GLAND PLATE	1	
1200		235230470016	HANDLE	1	
1200		235260470015	HANDLE	1	
1200		235260470017	HANDLE	1	
1200		235260470018	HANDLE	1	
1205		270839840149000000	SCREW [HANDLE >> COVER]	2	
1207		270830510100700000	SCREW [HANDLE]	2	
1208		27073051941100000	NUT [HANDLE]	2	
1210		232160272006	COVER	1	
1212		270839840149000000	SCREW [GROUND CABLE]	1	
1213		271770004020000000	WASHER [GROUND CABLE]	1	
1215		270830512281272018	SCREW [COVER >> MOTOR CASE]	4	
1216		271770085040000000	GASKET [COVER >> MOTOR CASE]	1	
1217		2750700072028	GASKET [COVER]	1	
1225		230660224209	UPPER BEARING HOLDER	1	
1230		230550271022	LOWER BEARING HOLDER	1	
1235		2729062010200000	UPPER BEARING	1	711365
1240		2729072010000000	LOWER BEARING	1	
1245		231030272014	MOTOR CASE	1	
1272		2750700072029	GASKET [LOWER BEARING HOLDER >> PUMP BODY]	1	
1301		270839840149000000	SCREW - STOP RING [COOLING JACKET]	4	
1310		238130272008	EXTERNAL COOLING JACKET	1	
1346		27542031000000	WAVE SPRING	1	
1365		238632121272015	MECHANICAL SEAL FLANGE	1	
1366		271770088035000000	GASKET [LOWER BEARING HOLDER >> MECHANICAL SEAL FLANGE]	1	
1368		237970140200600000	V-RING [MECHANICAL SEAL FLANGE]	1	
1369		27073051940100000	SCREW [MECHANICAL SEAL FLANGE >> PUMP BODY]	4	
1450		230005060120000000	MECHANICAL SEAL	1	
1600		230230211473005	SHAFT WITH ROTOR	1	
1610		231101141007000000	WOUND STATOR	1	
1737		2517012000000	CAPACITOR	1	710985
1745		254500405300000	FLOAT SWITCH	1	
1746		254505004000000	FLOAT SWITCH	1	

1800	21253021200072001	PUMP BODY		1
1805	21413000720573002	IMPELLER		1
1810	270830510160700000	LOCKING IMPELLER	800323 OR 803481	1
1868	216534672005	CLOSED STRAINER		1
1869	270830510510700000	SCREW [CLOSED STRAINER >> PUMP BODY]		3
1875	2160621272011	HYDRAULIC UNION RING		1