



Pump Model - version

EUROINOX 30-50 M - N.5. - -

Attention: check the correspondence with the serial number of the pump.

Company Name
Contact
Telephone
FAX
E-Mail address

Receiver

From

Serial Number

EUROINOX 30-50 M - N.5. - - @ 102970260_b

EUROINOX 30-50 M @ 102970260

Item	Quant	Item no.	Description	Unit pr.
1	1	R00005344	PUMP BODY	On req.
13	1	R00004183	FAN GUARD	On req.
12	1	R00004002	FAN	On req.
3	1	R00005145	SUPPORT	On req.
7	1	R00005288	MOTOR SHAFT	On req.
28	1	R00005306	OR	On req.
45	1	R00005312	NUTS AND BOLTS	On req.
19	1	R00005129	FRONT BEARING	On req.
20	1	R00005112	REAR BEARING	On req.
23	1	R00004009	CAPACITOR	On req.
4	3	R00005328	COMPLETE STAGE	On req.
11	1	R00004011	MOTOR COVER	On req.
10	1	R00005131	MOTOR	On req.
16	1	R00005282	SEAL	On req.
14	1	R00004811	TERMINAL BOARD	On req.
36	1	R00004016	MECHANICAL SEAL COVER	On req.
381	1	R00005309	SELF-PRIMING FLANGE	On req.
25	1	R00004017	LOAD PLUG	On req.
26	1	R00004018	DISCHARGE PLUG	On req.
251	1	R00005332	COMPLETE HYDRAULICS	On req.

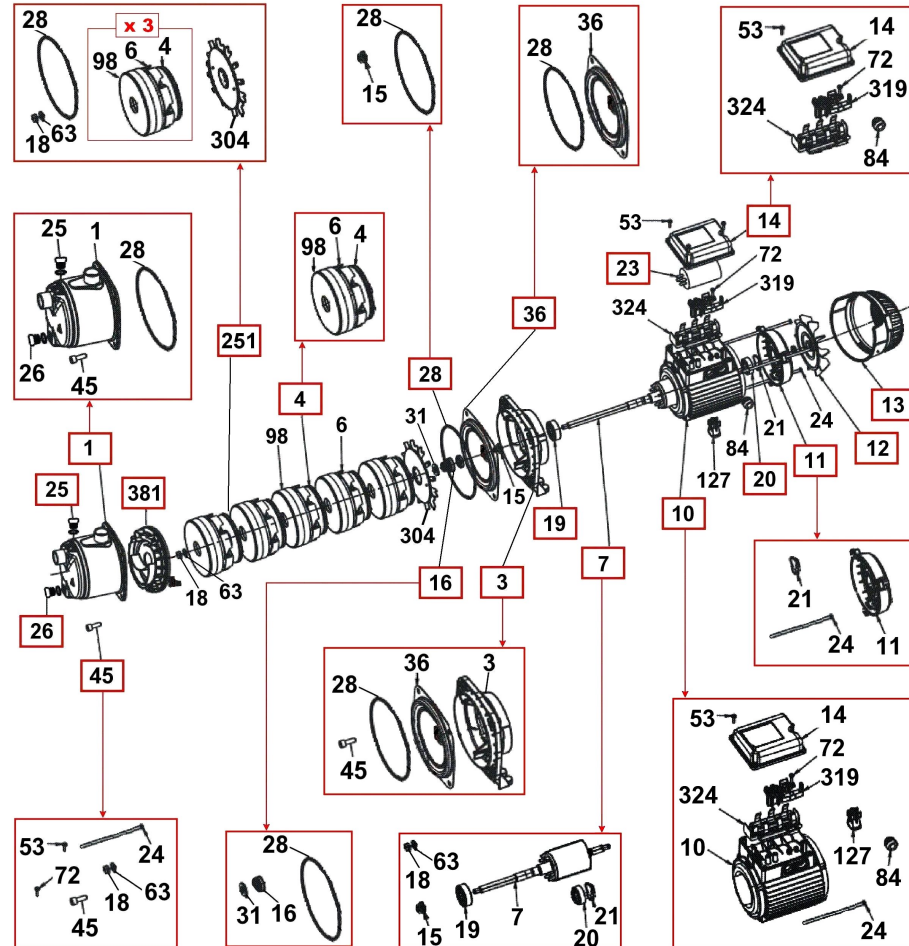

Project

Project ID

Created by

Created on
2011-01-06

Last update