

reflex

Thinking solutions.

PRODUCT PROFILE

REFIX DC 100 BLUE PRESSURE VESSEL 10 BAR

REF-DC100 – 806053



PRESSURE TANKS



PRODUCT DESCRIPTION

Reflex Tanks are highly constructed pressure tanks suitable for most domestic and commercial applications.

APPLICATIONS

- Booster Systems
- Borehole Systems
- Sprinklers
- Irrigation Systems
- HVAC
- Thermal Expansion
- Water hammer arresting

FEATURES & BENEFITS

- Manufactured in EU
- 316 Stainless Steel water connection
- Corrosion resistant for long life
- UV resistant epoxy coating with a minimum thickness of 30 micron in blue RAL5007
- Air valve with sealing cap eliminates leaks
- Food grade approved high-grade butyl membranes and bladders WRAS, ACS, AS NZS4020
- 5 Year Tank Replacement Guarantee

CHARACTERISTICS

- Nominal volume: 100L
- Nominal Draw-off: 36L
- Continuous max. temp 70°C
- Continuous max. pressure: 10 Bar
- Pre-charge: 4 Bar (58PSI)
- Diameter: 480mm
- Height: 782mm
- Net Weight: 21.1kg
- System Connection: GI
- Colour: BLUE RAL 5007

Certifications



WaterMark approved to WMTS-485:2018 Certificate No. 23340

whiteint.com.au/reflex



TECHNICAL SPECIFICATIONS

MATERIALS OF CONSTRUCTION

PART	MATERIAL
Pressure Tank	Steel
Internal Coating	Yes. Food Grade Approved
Water Connection	316 Stainless Steel
Air Valve Stem	Brass
Support Legs	Steel (Bolt Down) x 3
Membrane	Food Grade Approved
Bladder	N/A

SHIPPING REQUIREMENTS

CAUTION!

THE PRESSURE TANKS ARE PREFILLED WITH NITROGEN SO PLEASE ENSURE THAT YOU REMOVE GAS PRESSURE VALVE STEM BEFORE SHIPPING VIA AIRFREIGHT.

ENERGY SAVING DEVICE

- An energy saving device such as a Reflex Pressure Tank stores energy in the form of pressurized water.
- The energy is transformed by the pump from electricity to water pressure. With a Reflex tank there is no loss of energy once it has been stored in the device.
- By installing a Reflex Tank, the pump start events can be cut by 40 – 80%
- Saving Power
- Extending Pump Life
- Reducing Noise
- Low Initial Cost - The Reflex Tank is easy to fit to pumps and can even be wall mounted, the tank can be installed within minutes and can be fitted to any brand or type of pump.

SETUP & INSTALLATION

Pre-charge instructions

1. Pressure switch controlled pumps with differential pressure set at 140 kPa (20 psi), pre-charge the tank to 20 kPa (3 psi) below the cut in pressure.
2. For pumps controlled by pressure switches with higher differential pressures, electronic controls or variable speed controls, pre-charge the tank to 65% of the maximum system pressure.
3. Pressure tanks installed on mains pressure, pre-charge should be set at the mains pressure.
4. For hot water expansion, pre-charge should be set at the mains pressure.

DIMENSIONS 1: FRONT VIEW

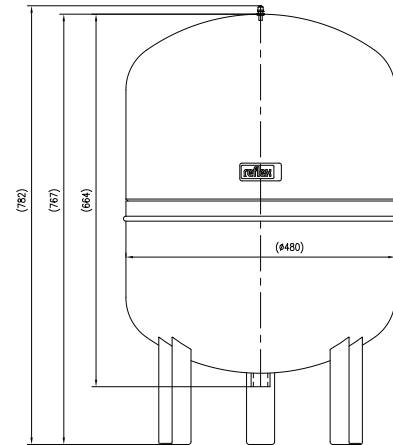

Front view

DIMENSIONS 2: SIDE & TOP VIEW

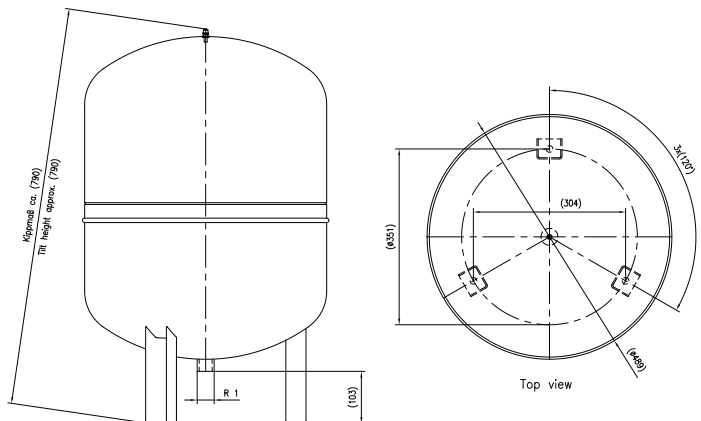

Side view

Top view

ACCESSORIES



Pressure Gauge
806109



Lockshield Valve
806109